

# PT510

Instrument Grade • 0..5 Vdc / 0..10 Vdc

Absolute Linear Position • Classic Stringpot Design  
Stroke Range Options: 0–2 to 0–100 inches  
Powder Painted & Anodized Aluminum Enclosure  
Industrial Automation & Testing Applications



## GENERAL

Full Stroke Range Options	0-2 to 0-100 inches
Output Signal Options	0...5, 0...10 VDC
Accuracy	see ordering information
Repeatability	± 0.05% full stroke
Resolution	essentially infinite
Measuring Cable	see ordering information
Enclosure Material	powder-painted and anodized aluminum
Sensor	plastic-hybrid precision potentiometer
Potentiometer Cycle Life	see ordering information
Maximum Retraction Acceleration	see ordering information
Weight	2 lbs. max.

## ELECTRICAL

Input	see ordering information
Input Current	10 mA maximum
Output Impedance	1000 ohms
Maximum Load	5000 ohms
Signal Adjustment, Zero	from factory set zero to 50% of full stroke range
Signal Adjustment, Span	to 50% of factory set span

## ENVIRONMENTAL

Enclosure	IP50, NEMA 1
Operating Temperature	-40° to 200°F (-40° to 90°C)
Vibration	up to 10 g to 2000 Hz maximum

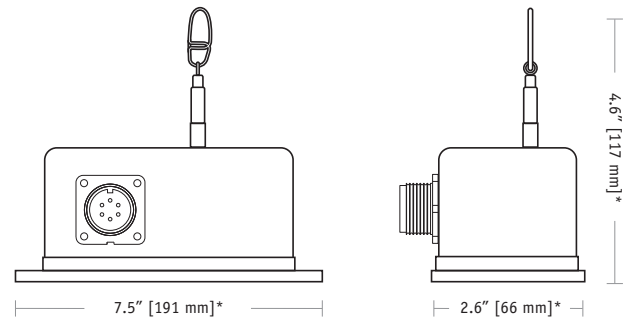

\*50-inch range model, dimensions may differ for other ranges

Based on Celesco's original string pot design dating back to the late 1960's, the PT510 has become a standard throughout the years for literally thousands of applications including aircraft structural testing, hydraulic cylinder control, valve stem opening, and factory automation.

Available in full stroke ranges up to 100-inches, the PT510 provides a regulated voltage feedback signal linearly proportional to the position of its traveling stainless steel measuring cable. Output signal options include 0-5 and 0-10 vdc.

## Electrical Output Signal

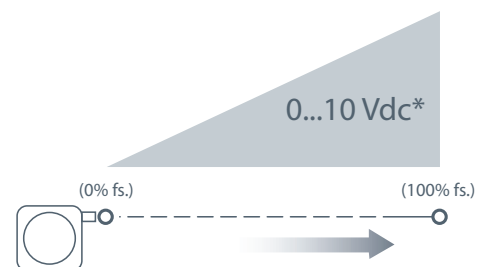

\*Additional Output Options: 0...5, -5...+5, -10...+10 Vdc

Fig. 1, Top Exit:

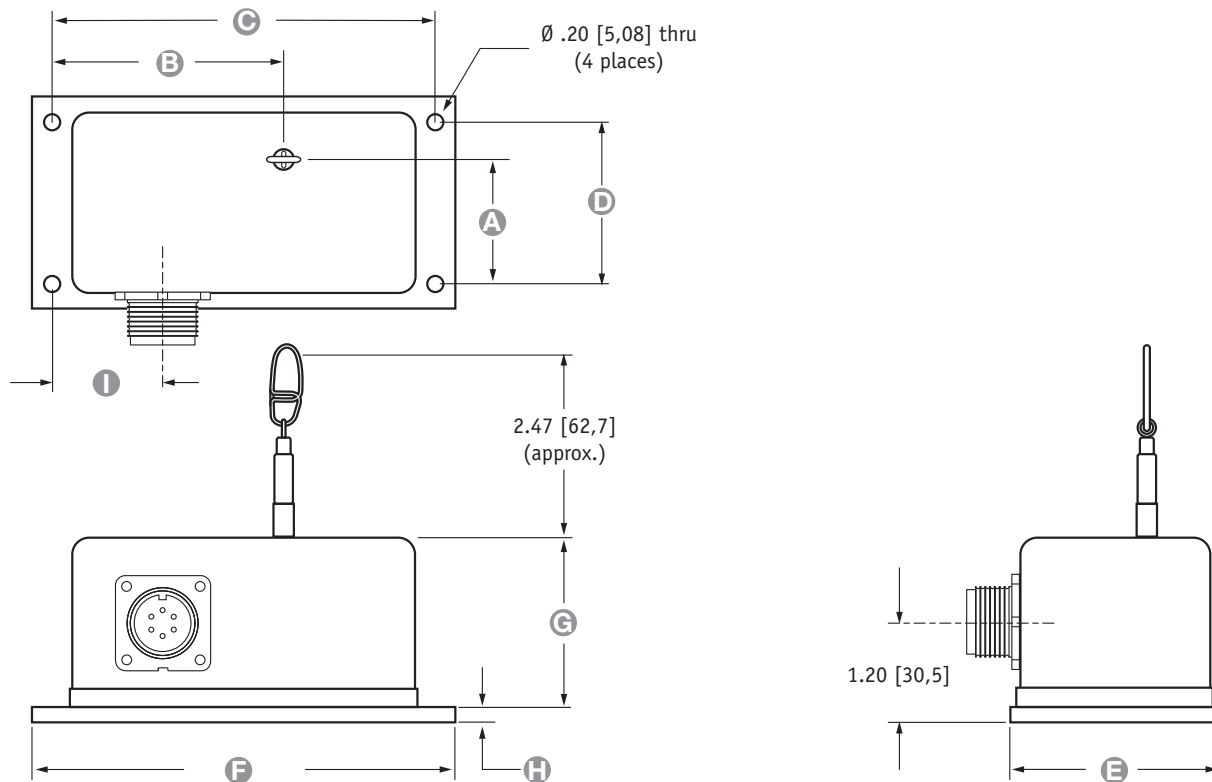

ALL DIMENSIONS ARE IN INCHES [MM] • tolerances are ±0.02 in. [±0,5mm]

Range	A	B	C	D	E	F	G	H	I
2", 10", 20"	1.34 [34,0]	4.00 [101,6]	7.00 [177,8]	2.00 [50,8]	2.63 [66,8]	7.50 [190,5]	2.10 [53,3]	.16 [4,1]	1.37 [34,8]
5", 25", 50"	1.83 [46,5]	4.00 [101,6]	7.00 [177,8]	2.00 [50,8]	2.63 [66,8]	7.50 [190,5]	2.10 [53,3]	.16 [4,1]	1.37 [34,8]
15", 30"	1.56 [39,6]	4.00 [101,6]	7.00 [177,8]	2.00 [50,8]	2.63 [66,8]	7.50 [190,5]	2.10 [53,3]	.16 [4,1]	1.37 [34,8]
40"	1.64 [41,6]	4.00 [101,6]	7.00 [177,8]	2.00 [50,8]	2.63 [66,8]	7.50 [190,5]	2.10 [53,3]	.16 [4,1]	1.37 [34,8]
60"	2.16 [54,9]	4.19 [106,4]	7.00 [177,8]	2.37 [60,2]	3.25 [82,5]	7.50 [190,5]	2.60 [66,0]	.19 [4,8]	1.37 [34,8]
75", 80"	2.45 [62,2]	4.38 [111,3]	6.75 [171,4]	2.50 [63,5]	3.63 [92,2]	7.50 [190,5]	2.86 [72,6]	.19 [4,8]	1.37 [34,8]
100"	3.10 [78,7]	4.19 [106,4]	7.38 [187,5]	3.00 [76,2]	4.25 [108,0]	8.00 [203,2]	3.79 [96,3]	.19 [4,8]	3.69 [93,7]

Ordering Information:

Model Number:

PT510 -      -      **1** - **1**           **0**  
order code:            R            A            B            C            D            E            F            G

Sample Model Number:

PT510 - 0025 - 111 - 1110

- R** range: 25 inches
- A** measuring cable tension: standard - 5 oz.
- C** cable exit: top
- E** output signal: 0...10 VDC
- F** electrical connection: 6-pin plastic connector

Full Stroke Range:

<b>R</b> order code:	0002	0005	0010	0015	0020	0025	0030	0040	0050	0060	0075	0100
full stroke range, min:	2 in.	5 in.	10 in.	15 in.	20 in.	25 in.	30 in.	40 in.	50 in.	60 in.	75 in.	100 in.
accuracy (% of f.s.):	0.28%	0.28%	0.18%	0.18%	0.15%	0.18%	0.15%	0.15%	0.15%	0.15%	0.15%	0.15%
potentiometer cycle life*:	2.5 x 10 <sup>6</sup>	2.5 x 10 <sup>6</sup>	5 x 10 <sup>5</sup>	5 x 10 <sup>5</sup>	5 x 10 <sup>5</sup>	5 x 10 <sup>5</sup>	5 x 10 <sup>5</sup>	2.5 x 10 <sup>5</sup>	2.5 x 10 <sup>5</sup>	2.5 x 10 <sup>5</sup>	2.5 x 10 <sup>5</sup>	2.5 x 10 <sup>5</sup>

\*-1 cycle is defined as the travel of the measuring cable from full retraction to full extension and back to full retraction

Ordering Information (cont.):

**Measuring Cable Tension:**





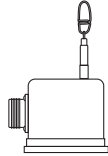
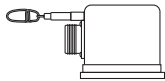
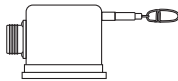
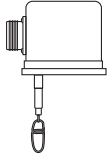

	1		H		2*	3*	
	standard tension tension, ±20%	max acceleration	high tension tension, ±40%	max acceleration			
2, 10, 20 inch range:	12 oz.	• 11 g	65 oz.	• 53 g	*note – outline dimensions for these options are not controlled on this datasheet!	72 oz.	144 oz.
5, 25, 50 inch range:	5 oz.	• 2 g	26 oz.	• 11 g		30 oz.	60 oz.
15, 30 inch range:	8 oz.	• 3 g	43 oz.	• 23 g		48 oz.	96 oz.
40 inch range:	6 oz.	• 4 g	33 oz.	• 16 g		36 oz.	72 oz.
60 inch range:	13 oz.	• 4 g	22 oz.	• 8 g		26 oz.	52 oz.
75, 80 inch range:	10 oz.	• 3 g	31 oz.	• 12 g		20 oz.	40 oz.
100 inch range:	13 oz.	• 5 g	52 oz.	• 20 g		26 oz.	52 oz.
measuring cable:	.019-in. dia. nylon-coated stainless steel					.024-in. dia. stainless steel	

**Measuring Cable Exit:**



1	2	3	4
top exit (see fig. 1)	front exit*	rear exit*	bottom exit*
			

\*—note: dimensions for optional cable exits not controlled on this datasheet, please contact factory

**Sensing Circuit:**

	1	2	3	4
output signal options:	0...10 VDC 	0...5 VDC 	10...0 VDC 	5...0 VDC 
input voltage:	14.5 - 40 vdc	10.5 - 40 vdc	14.5 - 40 vdc	10.5 - 40 vdc
Example:	ordercode = 1 = 0...10 vdc {  = 0 vdc  = 10 vdc			

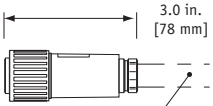
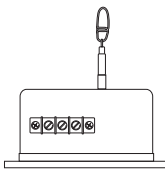
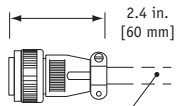
**Electrical Connection:**

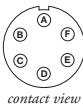
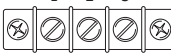
1	2	3	4																											
6-pin plastic connector with mating plug	terminal strip	6-pin metal connector with mating plug	25-ft. instrumentation cable 24 AWG, shielded																											
 1/2 - 5/16" [14 - 8 mm] cable dia. 16 AWG max conductor size connector: MS3102E-14S-6P mating plug: MS3106E-14S-6S		 3/8-in. [9 mm] max cable dia. 16 AWG max conductor size connector: MS3102E-14S-6P mating plug: MS3106E-14S-6S	 25 ft. x 0.2-in. dia. [7,5 M x 5 mm dia.] 24 AWG, shielded																											
<b>6-pin mating plug:</b> <table border="0"> <tr><td>pin</td><td>signals</td></tr> <tr><td>A</td><td>input voltage</td></tr> <tr><td>B</td><td>output signal</td></tr> <tr><td>C</td><td>common</td></tr> <tr><td>C</td><td>common</td></tr> <tr><td>E</td><td>common</td></tr> </table> 	pin	signals	A	input voltage	B	output signal	C	common	C	common	E	common	<b>Terminal Strip:</b>  <table border="0"> <tr><td>terminal</td><td>signals</td></tr> <tr><td>1</td><td>input voltage</td></tr> <tr><td>2</td><td>output signal</td></tr> <tr><td>3</td><td>common</td></tr> </table>	terminal	signals	1	input voltage	2	output signal	3	common	<b>25-ft. instrumentation cable:</b> <table border="0"> <tr><td>color code</td><td>signals</td></tr> <tr><td>RED</td><td>input voltage</td></tr> <tr><td>BLACK</td><td>common</td></tr> <tr><td>GREEN</td><td>output signal</td></tr> </table>	color code	signals	RED	input voltage	BLACK	common	GREEN	output signal
pin	signals																													
A	input voltage																													
B	output signal																													
C	common																													
C	common																													
E	common																													
terminal	signals																													
1	input voltage																													
2	output signal																													
3	common																													
color code	signals																													
RED	input voltage																													
BLACK	common																													
GREEN	output signal																													

## Output Signal Selection:

The output signal direction can be reversed at any time by simply changing the dip-switch settings found on the internal signal board. After the settings have been changed, adjustment of the Zero and Span trimpots will be required to precisely match signal values to the beginning and end points of the stroke.

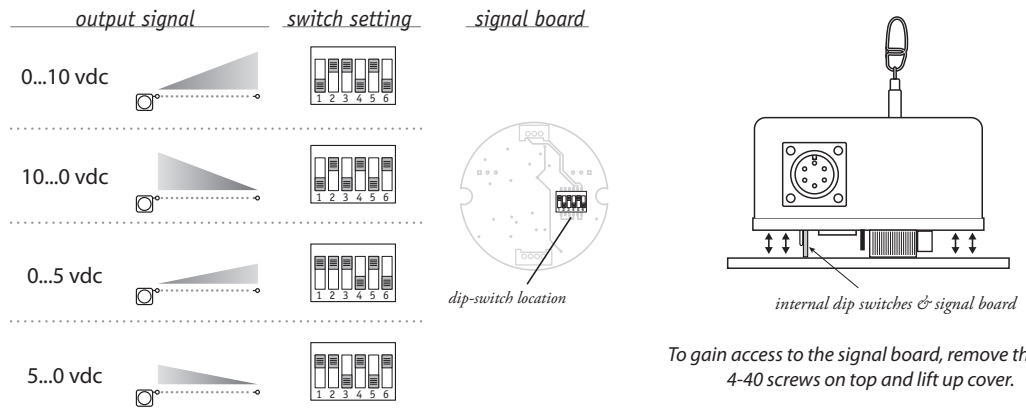

version: 6.0 last updated: December 4, 2012